

XF2M-5051-1A XF2M-5051-1A

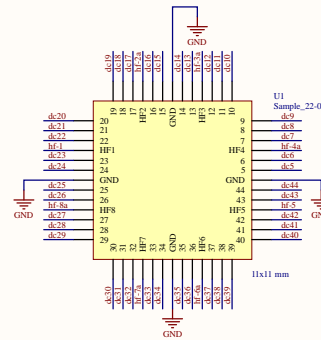

INPUT DATA		RESULTS	
Relative Dielectric Constant (ϵ_r):	<input type="text" value="3.5"/>	Effective Dielectric Constant (ϵ_{eff}):	<input type="text" value="2.547"/>
Track Width (S):	<input type="text" value="0.49"/> mm	Characteristic Impedance (Z_0):	<input type="text" value="50.08"/> Ohms
Gap Width (W):	<input type="text" value="0.15"/> mm	<input type="button" value="Calculate"/>	
Dielectric Thickness (h):	<input type="text" value="0.254"/> mm		

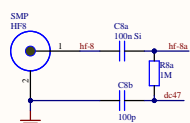
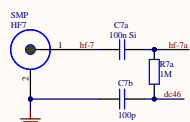
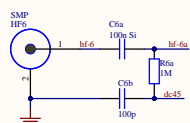
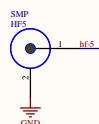
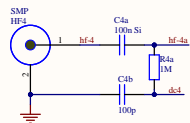
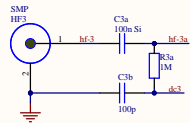
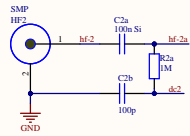
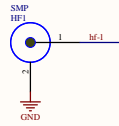
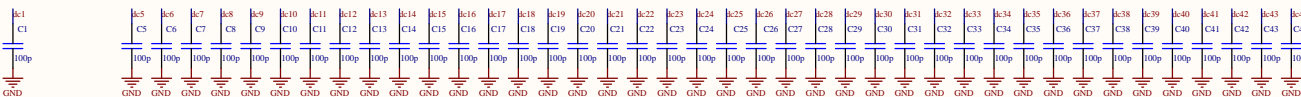

Board Stack Report